

***Newlink Fixed SKD Wall-Mount Enclosure  
W600mm-D450mm Black w/1 Fan***

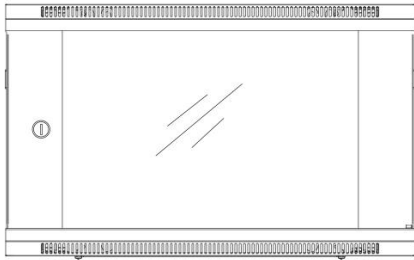

FRONT

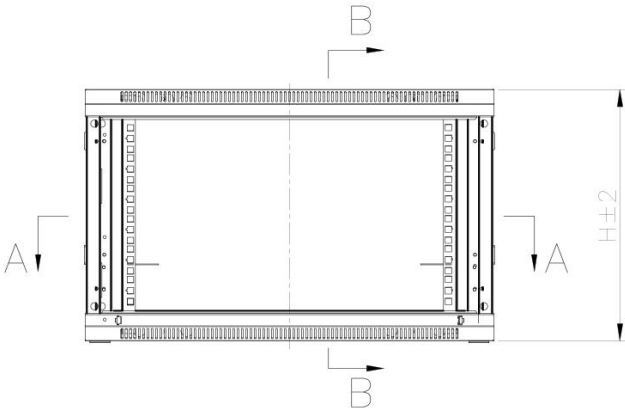

FRONT(without front door)

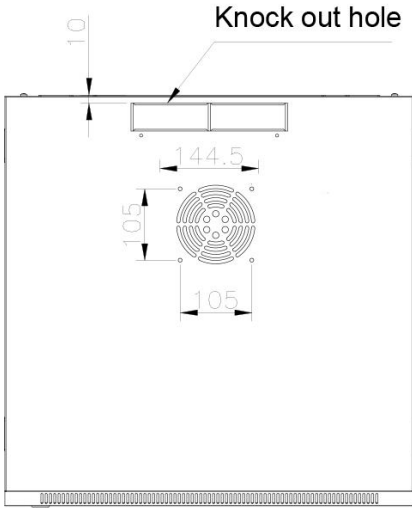

TOP

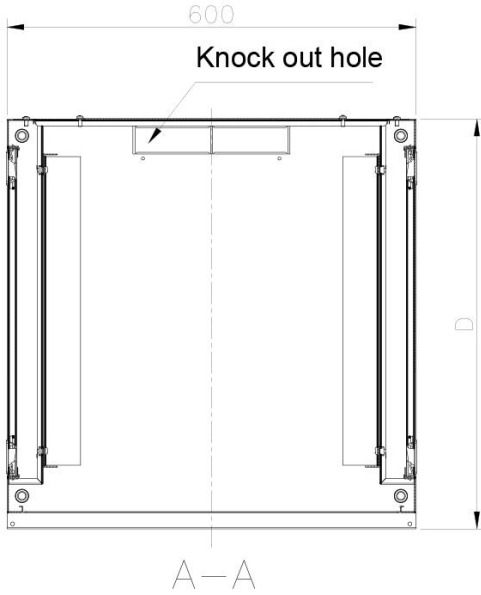

# NEWLINK

## Cabling Systems

NEW-09xxx99

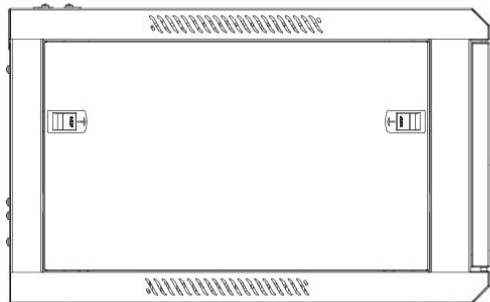

SIDE

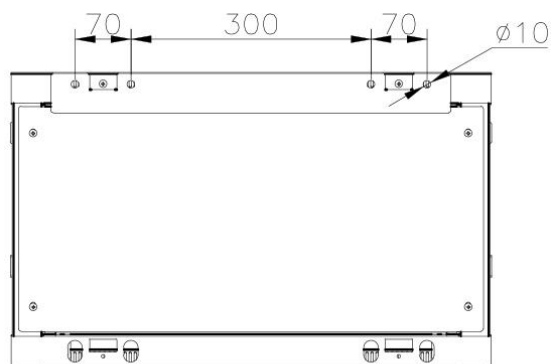

BACK

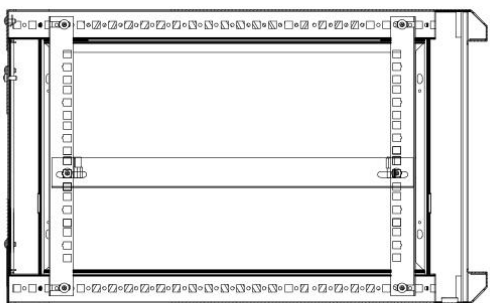

B-B

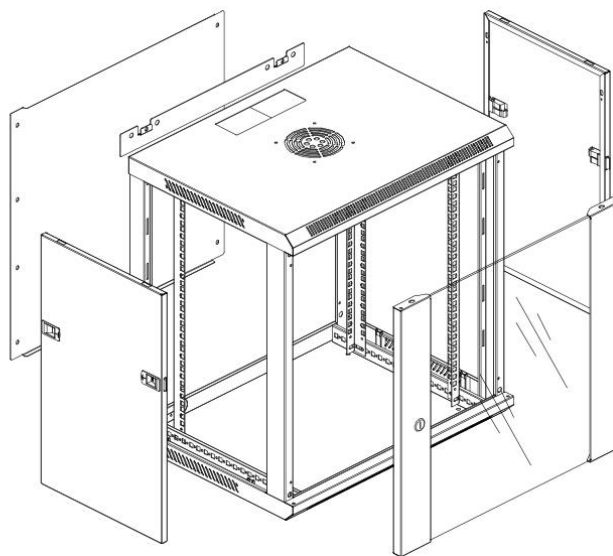

### Features:

- Welded frame, reliable structure
- Adjustable feet and heavy duty castors are optional
- Easy mounting installation
- 19" standard installation
- Removable side panels, side locks optional
- Cable entry on both of top cover and bottom panel
- 120mm fan available
- Turning angle of front door is over 180 degrees
- Standard: Comply with ANSI/EIA, RS-310-D, IEC60297-2, DIN41494;PART1, DIN41494;PART7
- Material: SPCC Cold Rolled Steel
- Thickness: back panel, side panel: 1.0mm, others: 1.2mm
- Loading capacity: Static loading: 60KG

#### Ordering Information:

**Description:** Newlink Fixed SKD Wall-Mount Enclosure W600mm-D450mm Black w/1 Fan

Part Number	Capacity (U)	D(mm)	H(mm)
NEW-0908199	4	450	279
NEW-0912299	6	450	368
NEW-0918199	9	450	500
NEW-0924199	12	450	635