



Catalog 2024

**NEWLINK**  
Cabling Systems

**Newlink... A Complete Solution!**  
[www.newlink-usa.com](http://www.newlink-usa.com)

Newlink is a leading manufacturer and supplier of Structured Cabling products in North America, Latin-America, and the Caribbean.  
Newlink offers...





## New Standards Available

<b>TIA-942-B:</b>	Telecommunications Infrastructure Standard for Data Centers
<b>TIA-1179-A</b>	Healthcare Facility Telecommunications Infrastructure standard
<b>ANSI/TIA-568.1-D-1:</b>	Commercial Building Telecommunications Infrastructure Standard Addendum 1: New
<b>Media Types:</b>	Category 8 copper and OM5 fiber.

## Internet of Things – Convergence of Power, Light and Data

### IoT application data and power requirements

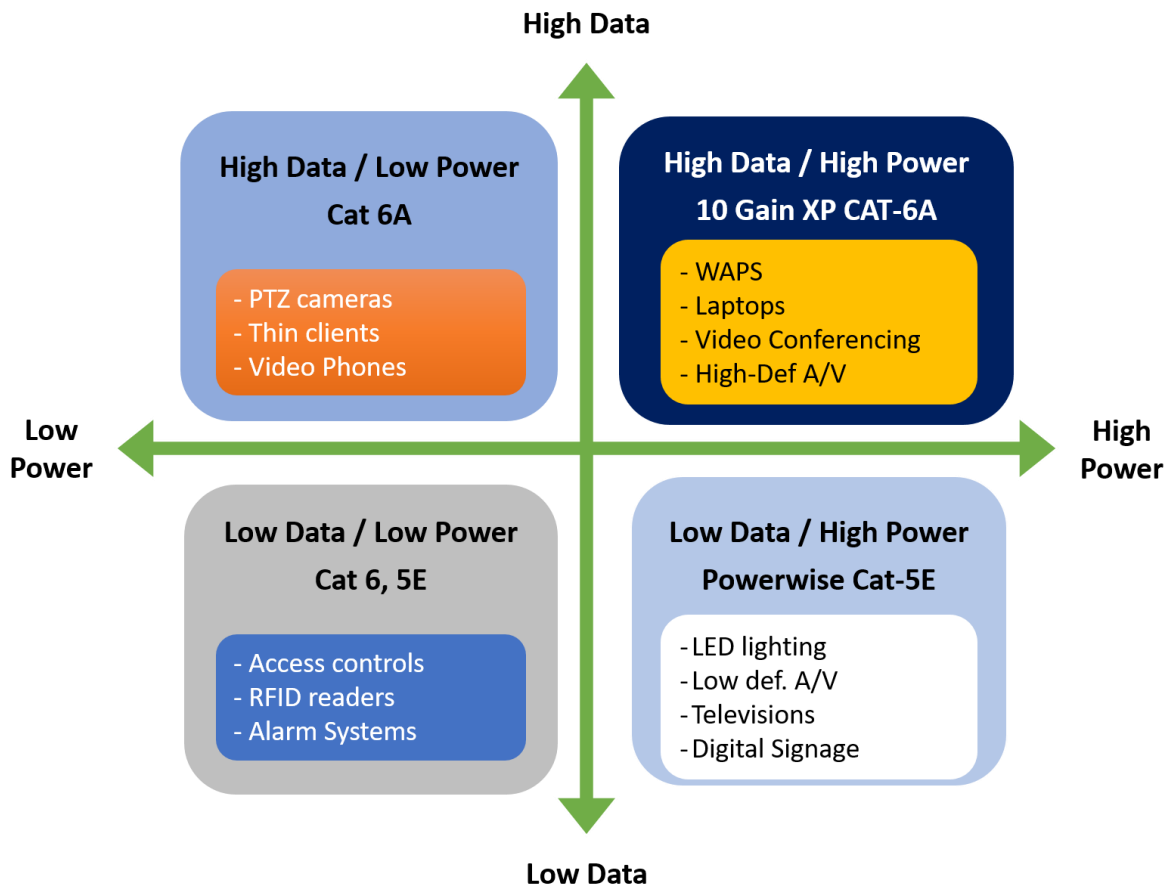

[Click here to see our Success Stories](#)

### Questions?

Contact us @ [support@newlink-usa.com](mailto:support@newlink-usa.com)

## CABLE TRAYS AND ACCESSORIES

NEWLINK Cable Trays and accessories offer versatility and heavy duty performance when a high volume of cable needs to be supported.

- Convenient Sizes
- Widths: 2", 4", 6", 8", 12"
- Depth: 2"
- Length: 3Mts
- Electro Zinc resistant finish
- NEC Approved

Part Number	Height		Width		Length	Diameter	Weight
	MM	INCH	MM	INCH	M	MM	KG/EACH
8504023	50	2	100	4	3	5	3.77
8506023	50	2	150	6	3	5	4.47
8508023	50	2	200	8	3	5	5.17
8512023	50	2	300	12	3	5	6.57



8508023

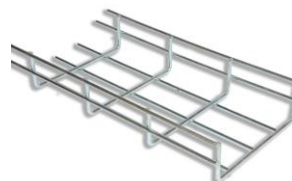









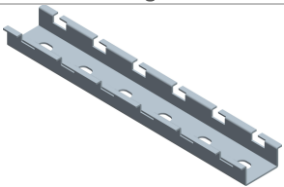
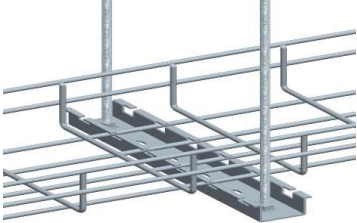
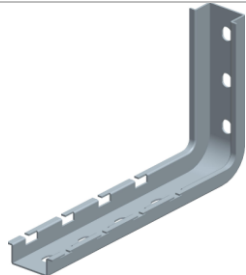
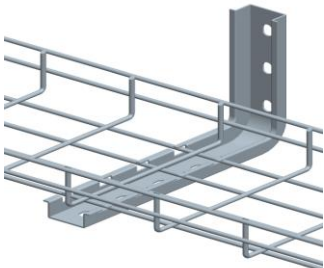



8506023

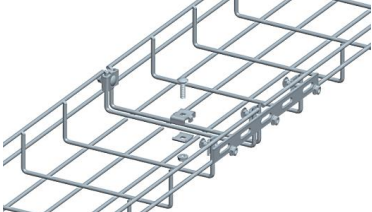

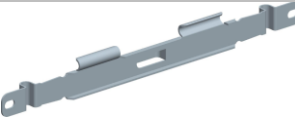
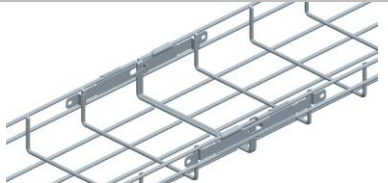
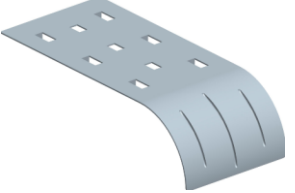
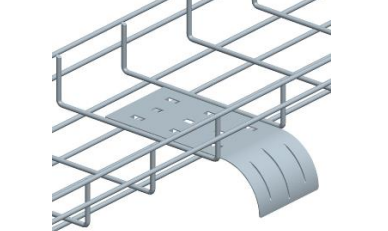
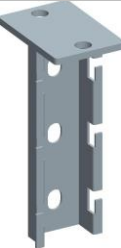
## QUICK REFERENCE TABLE FOR CABLE LOADS

Cable Tray	Fill Area	Loads in lbs/ft per span				Max. number of cables			
		5'	6'	7'	8'	Cat 5e 4-pair Plenum (.17")	Cat 5e 4-pair Non-plenum (.19")	Cat 6e 4-pair Plenum (.22")	Cat 6a 4-pair Non-plenum (.35")
8504023	8.06"	39.4	22.3	16.4	15.9	177	142	106	41
8506023	12.09"	46.5	27.6	20.3	19.1	266	213	159	62
8508023	16.12"	54.2	36.4	26.7	24.7	355	284	212	83
8512023	24.18"	71.6	47.1	34.6	31.7	532	426	318	125

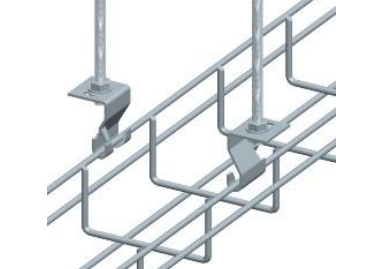
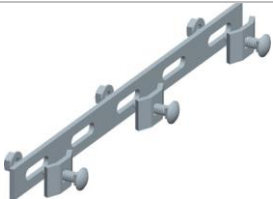
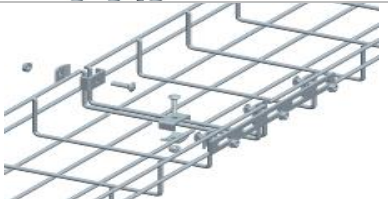
## FIXING & ACCESSORIES

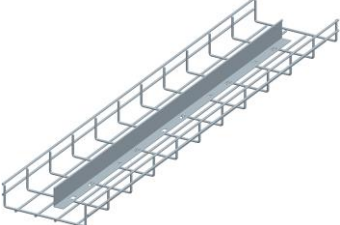
P/N	Images	Installing Guide	Description
8504010 8506010 8508010 8512010			<b>HANGER KITS</b> 1. Hanger kits are a solution for ceiling mounting. Each kit includes two 1mt metric thread rod, two anchor bolts, two flange nuts, and two common nuts. 2. These kits can be used as floor support.
8504050 8506050 8508050 8512050			<b>L-TYPE WALL BRACKET</b> This bracket is used to install cable trays to the wall. Designed for trays below 300mm wide. 8504050: 4" 8506050: 6" 8508050: 8" 8512050: 12"
8585100 8585200 8585300			<b>WALL BRACKET</b> It is used for horizontal wall mounting. Suitable for all sizes of cable trays. It supports heavy weight. 8585100: 4" 8585200: 8" 8585300: 12"
8585045			<b>FAS Profile (1mt)</b>
8585080			<b>FASTLOCK</b> Normally used with small cable trays to create a bend.
8530012			<b>PG SPLICE CE</b> Used to connect two separate cable trays. It requires at least 3 couplers. Standard couplers include one M6 bolt and one M6 flange nut.

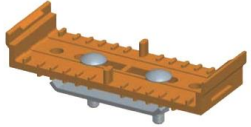
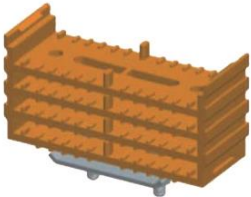
8595010			<p><b>FAST FIX SPLICER</b> It is used as a coupler. It connects two cable trays, but it doesn't support heavy weight.</p>
8955020			<p><b>CABLE GUIDER</b> It allows cables to be laid out from the trays to equipment.</p>
8595030			<p><b>T TYPE HANGING BRACKET</b> Used to hang the cable trays from the ceiling with vertical support.</p>
8599200			<p><b>GROUNDING BOLTS</b></p>
8599880			<p><b>HANGING HOOKS</b> Used to hang the cable trays from the ceiling. Designed for light weight.</p>
8585250			<p><b>STRENGTHENING BAR</b> It is used to strengthen the connection of two cable trays. It can also be used to create bends, tees, crosses, risers, and reducers.</p>
8599900			<p><b>DIVIDER</b> It is used to divide the cable tray into two cable pathways.</p>

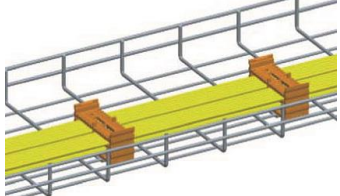
8598010			CABLE ROUTER BASE Apply to trays to organize cables. Made from ABS. Includes 1 set
8598011			CABLE ROUTER TOP Apply to trays to organize cables. Cable diameter 5mm-6mm. Includes 1 unit

Part Number	Description
8504023	Newlink EZ Cable tray 4" x 2" x 3 meters
8506023	Newlink EZ Cable tray 6" x 2" x 3 meters
8508023	Newlink EZ Cable tray 8" x 2" x 3 meters
8512023	Newlink EZ Cable tray 12" x 2" x 3 meters
8504029	Newlink EZ Cable Tray 4" x 2" x 2.90mts
8506029	Newlink EZ Cable Tray 6" x 2" x 2.90mts
8508029	Newlink EZ Cable Tray 8" x 2" x 2.90mts
8512029	Newlink EZ Cable Tray 12" x 2" x 2.90mts
8504010	Newlink PG Hanger-10 Kit for 8504023 (Kit includes: 1 bar, 2 rods, and 2 nuts)
8506010	Newlink PG Hanger-10 Kit for 8506023 (Kit includes: 1 bar, 2 rods, and 2 nuts)
8508010	Newlink PG Hanger-10 Kit for 8508023 (Kit includes: 1 bar, 2 rods, and 2 nuts)
8512010	Newlink PG Hanger-10 Kit for 8512023 (Kit includes: 1 bar, 2 rods, and 2 nuts)
8530012	Newlink PG Splice CF
8504050	FAS L Hanger 4"
8506050	FAS L Hanger 6"
8508050	FAS L Hanger 8"
8512050	FAS L Hanger 12"
8560000	Cable Tray Cutter
8585100	4" CRP Reinforced Bracket
8585200	8" CRP Reinforced Bracket
8585250	Strengthening Bar
8585300	12" CRP Reinforced Bracket
8585045	Fas Profile 1 meter
8585080	FasLock
8595010	Fast Fix Splicer
8595030	T-Type Hanging Bracket
8598010	Cable Fixer (Base)

8598011	Cable Fixer Top for 6mm cable (up to 4 per each 8598010)
8595020	Cable Guide
8597010	1" Conduit Connector
8597034	3/4" Conduit Connector
8599200	Grounding Bolt
8599880	Hanging Hooks
8599899	Corner Radius
8599900	Newlink Divider 2" x 1 meter (3 per tray needed)



## CAT-5E SOLUTIONS

ANSI/TIA/EIA-568 Category 5E products allow using all of the high-bandwidth demanding applications to the desk:

- 10BASE-T
- 100BASE-TX
- 100BASE-T4
- 1000BASE-T GIGABIT Ethernet
- ATM-25, 51, 155
- Tested up to 350 MHz
- Guaranteed +ACR beyond 200 MHz
- Extra NEXT headroom
- Cost-effective choice
- CAT-5E UTP Cables
- Patch Cords
- Patch Panels
- Jacks, Plugs, Boots
- Punch Down Blocks and Connecting Blocks

Part Number	Description
<b>CAT-5E UTP AND STP CABLES</b>	
9805441	Cat-5e UTP CERTIFIED 4 pair PVC CMR 1,000ft Gray
9805442	Cat-5e UTP CERTIFIED 4 pair PVC CMR 1,000ft Blue
9805351	Cat-5e STP CERTIFIED 4 pair PVC CMR 1,000ft Box Gray
9805061	OUTDOOR Cat-5e UTP CERTIFIED 4 pair gel filled 1,000ft black
9805361	OUTDOOR Cat-5e UTP CERTIFIED 4 pair GEL FREE UV Protection 1,000ft black
9805741	Cat-5e UTP CERTIFIED 4 pair PVC CM 1,000ft Gray
9805742	Cat-5e UTP CERTIFIED 4 pair PVC CM 1,000ft Blue
9805881	Cat-5e STP OUTDOOR 4 pair PVC 1,000ft Box Black PE
<b>CAT-5E PATCH PANELS</b>	
2594522	Wall mount Patch Panel Cat-5e UTP 12-Port RJ45 - Deluxe version
2594512	Rack mount Patch Panel Cat-5e UTP 12-Port RJ45 – Deluxe version
2594534	Rack mount Patch Panel Cat-5e UTP 24-Port RJ45 - Deluxe version
2594558	Rack mount Patch Panel Cat-5e UTP 48-Port RJ45 - Deluxe version
<b>CAT-5E PATCH CORDS</b>	
1ft = 0.305mts, 2ft = 0.61mts, 3ft = 0.915mts, 7ft = 2.134mts, 10ft = 3.048mts	
15801BL	Patch cord Cat-5e 50um Gold Blue 1ft
15801GN	Patch cord Cat-5e 50um Gold Green 1ft
15801GY	Patch cord Cat-5e 50um Gold Gray 1ft
15801RD	Patch cord Cat-5e 50um Gold Red 1ft
15801YW	Patch cord Cat-5e 50um Gold Yellow 1ft
15802BL	Patch cord Cat-5e 50um Gold Blue 2ft
15802GN	Patch cord Cat-5e 50um Gold Green 2ft
15802GY	Patch cord Cat-5e 50um Gold Gray 2ft
15802RD	Patch cord Cat-5e 50um Gold Red 2ft
15802YW	Patch cord Cat-5e 50um Gold Yellow 2ft
15803BL	Patch cord Cat-5e 50um Gold Blue 3ft
15803GN	Patch cord Cat-5e 50um Gold Green 3ft
15803GY	Patch cord Cat-5e 50um Gold Gray 3ft
15803RD	Patch cord Cat-5e 50um Gold Red 3ft
15803YW	Patch cord Cat-5e 50um Gold Yellow 3ft
15807BL	Patch cord Cat-5e 50um Gold Blue 7ft
15807GN	Patch cord Cat-5e 50um Gold Green 7ft
15807GY	Patch cord Cat-5e 50um Gold Gray 7ft
15807RD	Patch cord Cat-5e 50um Gold Red 7ft
15807YW	Patch cord Cat-5e 50um Gold Yellow 7ft
15810BL	Patch cord Cat-5e 50um Gold Blue 10ft
15810GN	Patch cord Cat-5e 50um Gold Green 10ft



9805441



2594558



15801XX



15801YW



15801RD

15810GY	Patch cord Cat-5e 50um Gold Gray 10ft
15810RD	Patch cord Cat-5e 50um Gold Red 10ft
15810YW	Patch cord Cat-5e 50um Gold Yellow 10ft
15815BL	Patch cord Cat-5e 50um Gold Blue 15ft
15820BL	Patch cord Cat-5e 50um Gold Blue 20ft
15825BL	Patch cord Cat-5e 50um Gold Blue 25ft
15850BL	Patch cord Cat-5e 50um Gold Blue 50ft
15875BL	Patch cord Cat-5e 50um Gold Blue 75ft
158100BL	Patch cord Cat-5e 50um Gold Blue 100ft
158200BL	Patch cord Cat-5e 50um Gold Blue 200ft
<b>CAT-5E JACKS, PLUGS, BOOTS</b>	
<b>CAT-5E - DELUXE JACKS</b>	
3555004	Cat-5e RJ45-110 Jack Snap Deluxe 50um gold GRAY
3555005	Cat-5e RJ45-110 Jack Snap Deluxe 50um gold ORANGE
3555006	Cat-5e RJ45-110 Jack Snap Deluxe 50um gold BLUE
3555007	Cat-5e RJ45-110 Jack Snap Deluxe 50um gold GREEN
3555008	Cat-5e RJ45-110 Jack Snap Deluxe 50um gold WHITE
3555009	Cat-5e RJ45-110 Jack Snap Deluxe 50um gold RED
3555010	Cat-5e RJ45-110 Jack Snap Deluxe 50um gold BLACK
3555015	Cat-5e RJ45-110 Jack Snap Deluxe 50um gold YELLOW
<b>CAT-5E - PLUGS</b>	
3584500	RJ45 8-Wire Cat-5e Plug (1000-pack)
3594501	RJ45 8-Wire Cat-5e Shielded Plug Solid 50um (1000-pack)
3584660	RJ45 8-Wire Cat 6 (Solid) Plug (1,000-pack)
3584770	RJ45 8-Wire Cat 6A (Solid) Plug (1,000-pack)
<b>CAT-5E - BOOTS</b>	
15100BL	RJ45 plug Boots 100pack Blue
15100GY	RJ45 plug Boots 100pack Gray



35500XX



3594501



15100BL

## CAT-6 AND CAT-6A SOLUTIONS



Our ANSI/TIA/EIA Cat-6 and Cat-6A family of products brings extra headroom for future applications. If you are installing today thinking in better performance and longer life cycle, CAT6 and 6A Solutions are the answer.

- 650 MHz TESTED Cables
- 25-year NEWMAX Warranty Program
- Newlink offers Cat-6 and 6A UTP cables, jacks, patch panels, patch cords, and connecting blocks

Part Number	Description
<b>CAT-6 and CAT-6A UTP AND STP CABLES</b>	
9806741	Cat-6 UTP CERTIFIED 4-pair 23AWG CM 1,000ft Box Gray
9806742	Cat-6 UTP CERTIFIED 4-pair 23AWG CM 1,000ft Box Blue
9806743	Cat-6 UTP CERTIFIED 4-pair 23AWG CM 1,000ft Box Red
9806341	Cat-6 UTP CERTIFIED 4-pair 23AWG CMR 1,000ft Box Gray
9806342	Cat-6 UTP CERTIFIED 4-pair 23AWG CMR 1,000ft Box Blue
9806351	Cat-6 STP CERTIFIED 4-pair 23AWG CMR 1,000ft Box Gray
9806161	OUTDOOR CAT-6 UTP CERTIFIED 4-pair gel filled 1,000ft Black
9806361	OUTDOOR CAT-6 UTP CERTIFIED 4-pair GEL FREE UV Protection 1,000ft Black
9806881	Cat-6 STP CERTIFIED 4-pair 23AWG 1,000ft Reel Black PE
9807301	Cat-6A 10G UTP CERTIFIED 4-pair 23AWG 1,000ft Reel Gray



9807302

9807302	Cat-6A 10G UTP CERTIFIED 4-pair 23AWG 1,000ft Reel Blue	
9807331	Cat-6A 10G STP CERTIFIED 4-pair 23 AWG 1,000ft Reel Gray	
<b>CAT-6A PATCH PANELS</b>		
2777712	Rackmount Modular Premium Patch Panel Cat 6A UTP 12-Port	
2777724	Rackmount Modular Premium Patch Panel Cat 6A UTP 24-Port	
2777748	Rackmount Modular Premium Patch Panel Cat 6A UTP 48-Port	
2773324	24-Port Cat 6A UTP Modular Angular Patch Panel	
2773348	24-Port Cat 6A UTP Modular Angular Patch Panel	
<b>CAT-6A PATCH CORDS</b>		
1ft = 0.305mts, 2ft = 0.61mts, 3ft = 0.915mts, 7ft = 2.134mts, 10ft = 3.048mts		
17701BL	Newlink Cat 6A UTP Patch Cord Molded 50um Blue 1ft	 <p>17701BL</p>  <p>3667708</p>
17701GY	Newlink Cat 6A UTP Patch Cord Molded 50um Gray 1ft	
17701RD	Newlink Cat 6A UTP Patch Cord Molded 50um Red 1ft	
17701YW	Newlink Cat 6A UTP Patch Cord Molded 50um Yellow 1ft	
17703BL	Newlink Cat 6A UTP Patch Cord Molded 50um Blue 3ft	
17703GY	Newlink Cat 6A UTP Patch Cord Molded 50um Gray 3ft	
17703RD	Newlink Cat 6A UTP Patch Cord Molded 50um Red 3ft	
17703YW	Newlink Cat 6A UTP Patch Cord Molded 50um Yellow 3ft	
17707BL	Newlink Cat 6A UTP Patch Cord Molded 50um Blue 7ft	
17707GY	Newlink Cat 6A UTP Patch Cord Molded 50um Gray 7ft	
17707RD	Newlink Cat 6A UTP Patch Cord Molded 50um Red 7ft	
17707YW	Newlink Cat 6A UTP Patch Cord Molded 50um Yellow 7ft	
17710BL	Newlink Cat 6A UTP Patch Cord Molded 50um Blue 10ft	
17710GY	Newlink Cat 6A UTP Patch Cord Molded 50um Gray 10ft	
17710RD	Newlink Cat 6A UTP Patch Cord Molded 50um Red 10ft	
17710YW	Newlink Cat 6A UTP Patch Cord Molded 50um Yellow 10ft	
17715BL	Newlink Cat 6A UTP Patch Cord Molded 50um Blue 15ft	
17720BL	Newlink Cat 6A UTP Patch Cord Molded 50um Blue 20ft	
17725BL	Newlink Cat 6A UTP Patch Cord Molded 50um Blue 25ft	
<b>CAT-6A JACKS</b>		
3667704	Cat-6A Keystone Jack T568A/B Gray	
3667705	Cat-6A Keystone Jack T568A/B Orange	
3667706	Cat-6A Keystone Jack T568A/B Blue	
3667707	Cat-6A Keystone Jack T568A/B Green	
3667708	Cat-6A Keystone Jack T568A/B White	
3667709	Cat-6A Keystone Jack T568A/B Red	
3667715	Cat-6A Keystone Jack T568A/B Yellow	
3667728	Cat-6A Keystone Jack T68A/B Ivory	
3899006	Cat 6A STP Jack Metallic Silver	

## COAXIAL SOLUTIONS

Coaxial cable is used as a transmission line for radio frequency signals. Its applications include feed lines connecting radio transmitters and receivers with their antennas, computer network (Internet) connections, and distributing cable television signals.

Part Number	Description
98RG580	RG58 Coaxial Cable 0.81mm BC + 2.95 SPE (1,000ft)
98RG622	RG6 75 ohm Coaxial Cable - 60% Braid FR PVC Black Jacket (1,000ft)
98RG644	RG6 75 ohm Coaxial Cable-60% Braid PE Outdoor Black Jacket (1,000ft)

## FIBER OPTIC SOLUTIONS

Newlink offers a wide variety of fiber optic products:

- ADSS, Armored, Loose Tube, Tight Buffer cables
- Connectors, strips, fiber optic boxes, patch cords, and termination tools and kits.

Fiber Optics Advantages for networking cabling systems:

- Longer distances
- Larger bandwidths
- Zero EMI/RFI interferences
- Isolates ground-loop issues
- Longer life cycle



Part Number	Description
9410004	4-Fiber Loose Tube Single mode Outdoor
9410006	6-Fiber Loose Tube Single mode Outdoor
9410012	12-Fiber Loose Tube Single mode Outdoor
9410024	24-Fiber Loose Tube Single mode Outdoor
9410048	48-Fiber Loose Tube Single mode Outdoor
9410072	72-Fiber Loose Tube Single mode Outdoor
9410096	96-Fiber Loose Tube Single mode Outdoor
9410144	144-Fiber Loose Tube Single mode Outdoor
9430004	4-Fiber Loose Tube Single mode Outdoor Armored
9430006	6-Fiber Loose Tube Single mode Outdoor Armored
9430012	12-Fiber Loose Tube Single mode Outdoor Armored
9430024	24-Fiber Loose Tube Single mode Outdoor Armored
9430048	48-Fiber Loose Tube Single mode Outdoor Armored
9430096	96-Fiber Loose Tube Single mode Outdoor Armored
9440006	6-Fiber ADSS Single mode Span= 100 meters
9440012	12-Fiber ADSS Single mode Span= 100 meters
9440024	24-Fiber ADSS Single mode Span= 100 meters
9440048	48-Fiber ADSS Single mode Span= 100 meters
9440096	96-Fiber ADSS Single mode Span= 100 meters
9468004	4-Fiber Loose Tube Multimode 62.5/125um Outdoor
9468006	6-Fiber Loose Tube Multimode 62.5/125um Outdoor
9468012	12-Fiber Loose Tube Multimode 62.5/125um Outdoor
9468024	24-Fiber Loose Tube Multimode 62.5/125um Outdoor
9469004	4-Fiber Loose Tube Multimode 50/125um Outdoor
9469006	6-Fiber Loose Tube Multimode 50/125um Outdoor
9469012	12-Fiber Loose Tube Multimode 50/125um Outdoor
9469024	24-Fiber Loose Tube Multimode 50/125um Outdoor
9465004	4-Fiber Loose Tube Multimode 50um OM3 10Gb Outdoor
9465006	6-Fiber Loose Tube Multimode 50um OM3 10Gb Outdoor
9465012	12-Fiber Loose Tube Multimode 50um OM3 10Gb Outdoor
9465024	24-Fiber Loose Tube Multimode 50um OM3 10Gb Outdoor
9480004	4-Fiber Loose Tube Multimode 62.5/125um Outdoor Armored
9480006	6-Fiber Loose Tube Multimode 62.5/125um Outdoor Armored
9480012	12-Fiber Loose Tube Multimode 62.5/125um Outdoor Armored



9480024	24-Fiber Loose Tube Multimode 62.5/125um Outdoor Armored
9481004	4-Fiber Loose Tube Multimode 50/125um Outdoor Armored
9481006	6-Fiber Loose Tube Multimode 50/125um Outdoor Armored
9481012	12-Fiber Loose Tube Multimode 50/125um Outdoor Armored
9481024	24-Fiber Loose Tube Multimode 50/125um Outdoor Armored
9530004	4 Fiber Tight-buffer Multimode 62.5/125um Indoor
9530006	6 Fiber Tight-buffer Multimode 62.5/125um Indoor
9531004	4 Fiber Tight-buffer Multimode 50/125um Indoor
9531006	6 Fiber Tight-buffer Multimode 50/125um Indoor
9535004	4 Fiber Tight-buffer Multimode 50/125um OM3 10Gb Indoor
9535006	6 Fiber Tight-buffer Multimode 50/125um OM3 10Gb Indoor
9535008	8 Fiber Tight-buffer Multimode 50/125um OM3 10Gb Indoor
9535012	12 Fiber Tight-buffer Multimode 50/125um OM3 10Gb Indoor

FIBER OPTIC DISTRIBUTION BOXES AND ACCESSORIES	
2670024	Rack mount Fiber Box 24-ports ST Ready (2 x 12 Unloaded ST plates). Comes with Splice Kit Tray
2670048	Rack mount Fiber Box 48-ports ST Ready (4 x 12 Unloaded ST plates). Comes with Splice Kit Tray
2681124	24 Port Wall mount Fiber Box ST Ready. For SC add 28900xx
2890010	12-port SC/UPC plate (loaded) for 2670024 , 2670048 and 2681124
2890015	12-port SC/APC plate (loaded) for 2670024 , 2670048 and 2681124
2890020	12-port LC plate (loaded) for 2670024 , 2670048 and 2681124
2890030	12-port FC plate (loaded) for 2670024 , 2670048 and 2681124
2890040	Blank plate for 2670024, 2670048, 2681124
FIBER OPTIC CONNECTORS AND COUPLERS	
3580001	ST-ST Coupler Simplex
3580002	SC-SC Coupler Simplex
3580003	LC-LC Coupler Simplex
3580012	SC-SC Coupler Duplex
3580013	ST-SC Coupler Duplex
312167M	ST Connector Multimode Simplex Ceramic
312168M	ST Connector Single mode Simplex Ceramic
321175M	SC Connector Multimode Simplex
321176M	SC Connector Single mode Simplex (While supplies Last)
340088S	LC Connector Single mode Simplex Ceramic
340187M	LC Connector Multimode Simplex Ceramic



2670024



3580002

## Fiber Optic Patch Cords

Fiber optic patch cables can be used for cross connects and work area connections. NEWLINK fiber optic patch cables are available in both multimode and single-mode.

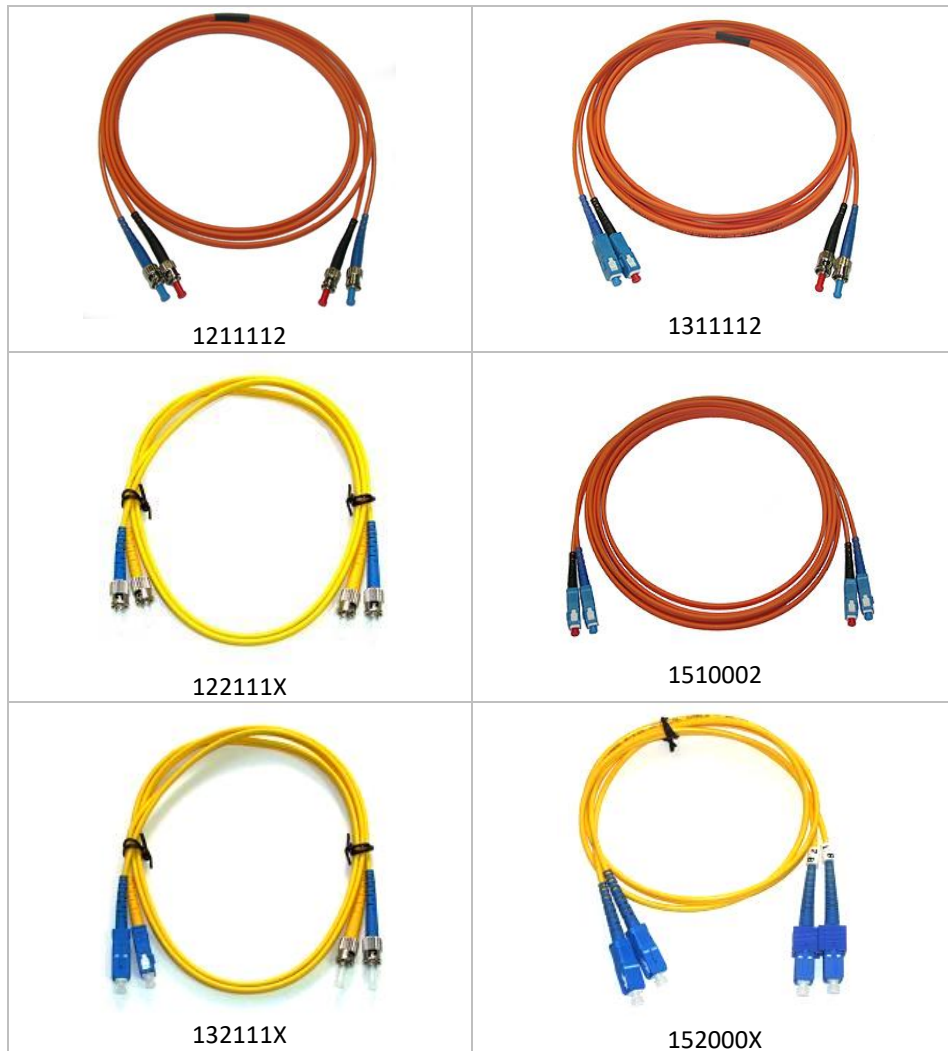

### Fiber Optic Patch Cords – Part Number Chart

Example	A	B	C	D	E	F	G	
<b>100101D:</b>	<b>100</b>			<b>1</b>		<b>01</b>	<b>D</b>	
	See chart below			MM / SM		Length in mt		D=Duplex S=Simplex
				1=MM 62.5um 2=MM 50um OM2 3=SM G652D 5=MM 50um OM3 6=MM 50um OM4 8= SM G655 9= SM G657				
	ABC							
		ST	SC	LC	FC	MTRJ	SC/APC	LC/APC
	ST	100	101	102	103	104	105	106
	SC	101	110	111	112	113	114	115
	LC	102	111	120	121	122	123	124
	FC	103	112	121	130	131	132	133
	MTRJ	104	113	122	131	140	141	142
	SC/APC	105	114	123	132	141	150	151
LC/APC	106	115	124	133	142	151	160	
Pigtails	109	119	129	139	149	159	169	
<b>EXAMPLES:</b>	<b>NEW-100101D</b>	Patch Cord ST-ST MM 62.5UM Duplex 1mt						
	<b>NEW-139304S</b>	Pigtail FC SM Simplex 4 mts						

## WALL PLATES AND SURFACE BOXES

With our elegant line of faceplates and outlet boxes your installation will be completed professionally and in compliance with the TIA/EIA 569A standard for the Work Area. NEWLINK flat-style wall plates combine high capacity with aesthetics. They offer a fresh look to match today's technologies. Available in single-snap 1, 2, 3, 4, and 6 ports, white and ivory. Surface boxes are perfect for installations where the Work Area outlet cannot be recessed into a wall or floor box. Available in white and ivory, 1 and 2 ports.

Part Number	Description
4000001	Wall Plate 1-port Single Snap White
4000002	Wall Plate 2-ports Single Snap White
4000003	Wall Plate 3-ports Single Snap White
4000004	Wall Plate 4-ports Single Snap White
4000005	Surface Mount Box White
4000006	Wall Plate 6-ports Single Snap White
4000012	Blank Insert White (use with 4000001,2,33,34,36,44,45,47)
4000013	Blank Insert Ivory (use with 4000021,22,23,24,25)
4000015	Surface Mount Box Ivory
4000021	Wall Plate 1-port Single Snap Ivory
4000022	Wall Plate 2-ports Single Snap Ivory
4000023	Wall Plate 3-ports Single Snap Ivory
4000024	Wall Plate 4-Ports Single Snap Ivory
4000026	Wall Plate 6-ports Single Snap Ivory
4000044	Wall plate only 45-degree 1 RJ45 White
4000045	Wall plate only 45-degree 2RJ45 White
4000047	Wall plate only 45-degree 4RJ45 White
4000054	Wall plate only 45-degree 1 RJ45 Ivory
4000055	Wall plate only 45-degree 2RJ45 Ivory
4000101	Surface Jack Box 1-Port White (use with 35000xx, 366xxxx)
4000102	Surface Jack Box 2-Port White (use with 35000xx, 366xxxx)
4000104	Surface Jack Box 4-port White (use with 35000xx, 366xxxx)
4000201	Surface Jack Box 1-Port Ivory (use with 35000xx, 366xxxx)
4000202	Surface Jack Box 2-Port Ivory (use with 35000xx, 366xxxx)



4000002



4000005





4000055

## RACKS AND CABINETS

- NEWLINK offers a comprehensive line of racks and cabinets for the Telecommunications industry.
- Our racks meet the EIA-310D spacing standard specifications and follow the TIA-569A standard guidelines.
- NEWLINK provides wall mount cabinets for equipment protection and proper cabling termination. They reduce floor space requirements and are the best option for overcrowded offices and telecommunications rooms.
- Our Free Standing Cabinets are designed to provide protection to your telecommunications equipment.

Part Number	Description
0841025	24RU Rack Steel 4' x 19" Black Powder Coated
0842016	45RU Rack Aluminum 7' x 19" Black Powder Coated
0842031	Rack Steel 7' x 19" 45UR Black (square holes) (Do not use this rack with Vertical Wire Brackets 03350XX)
0842033	Screw/Nut kit for 0842031 100-pack (does not fit 0842016)
0842045	45RU Rack Steel 7'x 19" Black Powder Coated
0842036	Screw for 0842035 (100-pack)



0844010	45RU 4-Post Adjustable Rack 7' x 22" or 40" Depth, Black Steel	
<b>CABINETS</b>		
0912020	6RU (14.5" x 23.5" x 21") Wall mount Enclosure Glass Door, Side Panels and fan included	
0912299	6RU Fixed Wall mount Enclosure W600mm-D450mm Black w/1 Fan and back panel	
0918030	9RU (19" x 23.5" x 21") Wall mount Enclosure Glass Door Side Panels and fan included	
0924218	12RU (24" x 23.5" x 21") Wall mount Enclosure Glass Door, Side Panels and fan included	
0934015	15RU (30" x 23.5" x 21") Wall mount Enclosure Glass Door and fan included	
0939020	20RU (39" x 23.5" x 21") Wall mount Enclosure with Glass Door. Fan included	
0951027	27RU (51" x 23" x 21") Wall mount Enclosure, Front Glass Door and fan included	
0947501	24RU (47") Cabinet Ventilated Doors extra depth (42.13') 2 fans power strip	
0978301	42RU (78") Cabinet, Glass Door (2 fans, 1 power strip included)	
0978401	42RU (78") Cabinet, Ventilated Door (2 fans, 1 power strip included)	
0978501	42RU (78") Cabinet Ventilated Front/Back Doors, extra depth 42.13" 2fans/1 Power Strip	
<b>SERIES 300 CABINETS – UNASSEMBLED</b>		
0924300	24" (12RU) Wall mount Glass Door Unassembled-No Back Door	
0934300	30" (15RU) Wall mount Glass Door Unassembled-No Back Door	
0951300	51" (27RU) Wall mount Glass Door Unassembled	
0978300	78" (42RU) Cabinet, Glass Door Unassembled (2 fans, 2 power strip included)	
0978400	78" (42UR) Cabinet, Ventilated Door Unassembled (2 fans, 2 power strip included)	
0978500	78" (42RU) Cabinet Extra Depth (42.13") Unassembled	



0842031

0918030

## RACKS AND CABINETS' ACCESSORIES

NEWLINK provides a variety of accessories to help you keep your telecommunications room in perfect conditions.

- Shelves
- Cable Organizers
- Power Supplies
- Wall Mount Brackets

Part Number	Description		
0445020	2-position Wall Mount Bracket 12" Panel Depth		
0445030	3-position Wall Mount Bracket 12" Panel Depth		
0455040	4-position Wall Mount Bracket 12" Panel Depth		
0455060	6-position Wall Mount Bracket 12" Panel Depth		
0191446	19" Sliding Keyboard/ Shelf and Mouse Pad		
0191447	19" Sliding Keyboard/Shelf		
0191451	19" Sliding Vented Shelf 4-point mounting 24" Depth 120 lbs		
0191452	19" Solid Center Weight Rack Shelf 19" Depth 60 lbs		
0191453	19" Solid Cantilevered Weight Rack Shelf 14" Depth 50lbs		
0191454	19" Vented Shelf 4-point mounting 30" Depth 200 lbs		
0191461	19" Sliding Vented Shelf 22" Depth 77lbs		
0191510	19" Cantilevered Vented Shelf 12" Depth 70 lbs		
0191511	19" Flush Cantilevered Solid Shelf 12" Depth 70 lbs		
0191512	19" Flush Mount Cantilevered Vented Shelf 14" Depth 50 lbs		
0191518	19" Flush Cantilevered Vented Shelf 18" Depth 75 lbs		
0165000	Vertical Cable Hanger 1-Hook 3.75" x 3.75"		
0201021	Horizontal 2U-1 Side Duct Panel with Cover 3.5" x 19"		
0201023	Horizontal 2U-2 Side Duct Panel with Cover 3.5" x 19"		
0205002	Horizontal Cable Organizer 5-Rings 1U Rack		
0301001	2-pack Horizontal 1U-1 Side Duct Panel with Cover 1.75" x 19"		
0336010	Vertical Wire Bracket 1-Side 36" H x 4" W Black		

0455040

0191452

0191512

0336020	Vertical Wire Bracket 2-Side 36" H x 4" W Black	 0201023
0336040	Vertical Wire Bracket 2-Side 72"H x 4" W Black (only for 0842016 and 0844010)	
0516208	8-Outlet Power Strip Rack Mount with thermal protector	
0516210	10-Outlet Power Strip Rack mount 15A with Surge Protector	
0516220	20-Outlet Power Strip Vertical 15A with surge protection	
0617519	Filler Panel 1-U	
0635019	Filler Panel 2-U	
0652519	Filler Panel 3-U (this item includes 2 panels)	
0990004	1U 10" Fan Tray (4 fans)	



## CABLE TIES AND LABELING PRODUCTS



Cable ties allow you to tie and identify bundles of wires and cable in one operation. The Velcro grip tie is a low profile, one-piece fastening device. Constructed of Velcro, polyethylene hook and nylon loop, laminated back to back, the grip tie features quick release for repetitive access. Cable ties will not cause damage to Category 6, 5E or Fiber Optic cables, avoiding over stresses. Nylon and Velcro cable ties available in several colors and lengths.

Part Number	Description	 8212502
8212502	Velcro Grip Tie Roll 3/4" x 4.5meters Black	
8111602	Velcro Grip Tie 10" 50lbs Black 100-PK	
8204001	Plastic Cable Tie 4" Identifiable 200-PK	
8204029	Heavy Duty Cable Tie 29" Black 25-pack	

## KITS, TOOLS, AND TESTERS

Newlink provides tools and testers for the everyday technician's requirements. Choose the right tool for the right job, for Fiber Optics as well as for UTP cabling.



Part Number	Description	 5010011   5554508
5020001	Easy Stripper for UTP/STP Telecom Wire	
5110001	Replacement 66/110 blade for 5584510	
5554508	Multifunction Modular Plug Crimper	
5584444	4 in 1 Mini Network Tool Kit	
5566000	Modular Crimping Tool	
5584510	Punch Down Tool 66/110 Low and High Impact	
5584235	Junior tool kit (includes: Professional crimping tool for RJ45, RJ12, RJ11 Punch Down tool, wire stripper, screw driver 3 x 50mm, Cable Tester Network to BNC connector wire 2-pieces, (10) 8p8c and (10) 6p4c modular plugs, (1) BNC plug, Tool Bag	
5584755	Pro Took Kit (This kit includes: Professional crimping tool with 4pcs dies set,	



	Professional modular plug crimping tool, Punch down tool with 110/66 blades 4.5" diagonal cutting plier, 7 in 1 wire stripper & wire cutter, Round cable cutter, 7pcs folding type hex key wrench, Coaxial wire stripper Knife, 4.5" long nose plier, 6pcs electronic screwdriver set, 6pcs cushion-grip nut driver screwdriver set, 5 in 1 precision screwdriver, 2mt/6ft measure tape, Network cable tester	 5566000
5594699	Newlink Multifunctional Network Cable Tester BNC RJ11 RJ12 RJ45	 5584510
5594753	Remote Cable Tester RJ45/RJ11/USB and BNC - 8 leds	 5584755
5594883	Professional USB/LAN/9 Multi-modular Cable Tester	
5594963	Multimeter AC/DC Resistance/Continuity w/lard LCD Display	

## RACEWAYS AND ACCESSORIES

NEWLINK raceways and accessories bring flexibility and capacity for the small-volume required at cable drops.

- Elegant design
- Widths: 19mm and 32mm (3/4" and 1-1/4")
- Ivory and White color
- Fire retardant 94V-0 PVC
- TIA/EIA 569A bending and radii
- Adhesive-backed for easy mounting

Part Number	Description	
7788016	2-piece Raceway with Adhesive Tape 16mm x 16mm x 2mts White (72 per box)	 7003402
7788030	2-piece Raceway with Adhesive Tape 30mm x 13mm x 2mts White (20 per box)	
7788040	2-piece Raceway without Adhesive Tape 40mm x 25mm x 2mts White (20 per box)	
7003402	Splice Cover 3/4" White	 7203402
7003408	Splice Cover 3/4" Ivory	
7003412	Tee Cover 3/4" 1" Bend White	
7003418	Tee Cover 3/4" 1" Bend Ivory	 Raceways
7011402	Splice Cover 1 1/4" White	
7011408	Splice Cover 1 1/4" Ivory	
7011412	Tee Cover 1 1/4" 1" Bend White	
7011418	Tee Cover 1 1/4" 1" Bend Ivory	
7113462	Raceway 1 1/4" x 3/4" x 6' White. Factory Adhesive Backing	
7113468	Raceway 1 1/4" x 3/4" x 6' Ivory. Factory Adhesive Backing	
7203402	Ceiling Drop 3/4" White	
7203408	Ceiling Drop 3/4" Ivory	
7211402	Ceiling Drop 1 1/4" White	
7211408	Ceiling Drop 1 1/4" Ivory	
7341262	Raceway 3/4" x 1/2" x 6' White. Factory Adhesive Backing	
7341268	Raceway 3/4" x 1/2" x 6' Ivory. Factory Adhesive Backing	
7341269	Raceway 1 3/4" x 1" x 6' White, Factory Adhesive Backing	
7403402	Elbow Cover 3/4" White	
7403408	Elbow Cover 3/4" Ivory	
7411402	Elbow Cover 1 1/4" White	
7411408	Elbow Cover 1 1/4" Ivory	
7503402	End Cap 3/4" White	
7503408	End Cap 3/4" Ivory	
7511402	End Cap 1 1/4" White	

7511408	End Cap 1 ¼" Ivory	 7503402	
7603402	External Cover ¾" White		
7603403	External Cover ¾" 1" Bend White		
7603408	External Cover ¾" Ivory		
7611402	External Cover 1 ¼" White		
7611408	External Cover 1 ¼" Ivory		
7703412	Internal Cover ¾" 1" Bend White		
7703418	Internal Cover ¾" 1" Bend Ivory		
7711412	Internal Cover 1 ¼" 1" Bend White		 7403402
7711418	Internal Cover 1 ¼" 1" Bend Ivory		
7834102	Junction Box Single Gang White		
7834108	Junction Box Single Gang Ivory		
7911342	Reducer 1 ¼" to ¾" White		
7911348	Reducer 1 ¼" x ¾" Ivory		
7912542	Reducer 1 3/4" to 1 ¼" White		
7912548	Reducer 1 3/4" to 1 ¼" Ivory		



## Get Online Now!

Newlink invites you to scan these QR codes with your smartphone to access our website and to watch our video about how to install our Cable trays:



[www.newlink-usa.com](http://www.newlink-usa.com)



[You Tube VIDEO "How to Install Flexible Cabletrays"](#)

Need Technical Specs? Need UL Certificates?  
Just email us your request: [support@newlink-usa.com](mailto:support@newlink-usa.com)